



A WATTS Brand

# S19314EW

## Combination Drench Shower and Halo™ Eyewash

- Halo™ and SpinTec™ Deliver the Most Effective Shower and Eye Washdown Coverage and Spray Pattern
- Exceeds ANSI/ISEA Z358.1 Specifications
- Industry's Only Self-Draining Design – The Aquaduct™
- Separate Supply and Waste Pipes – Meets CEN and Plumbing Requirements
- Ergonomic Hand Activation Eyewash Paddle – Easy to Reach from Any Direction
- Fully-Assembled and Factory-Tested Eyewash with Hinged Dust Covers
- Universal Identification Sign and Inspection Tag Included
- Classified by Underwriters Laboratories Inc. to ANSI/ISEA Z358.1.
- SpinTec showerheads are covered by one or more of the following patents: 8,113,446; 7,806,348; 8,490,895; D594,089; D669,555; Reg. Comm. Des. D001079560-0001. Other patents pending.
- Halo is Covered by One or More of the Following Patents: 9,700,484; 9,314,398; D662220; D673298; D662605; D685920; D662219; and D671228. Other Patents Pending.



### Specifications

Standard Combination Drench Shower/Eyewash Units save space and fit easily into any work environment. Shower valve operates quickly by a pull rod with a triangular handle. Shower provides a superior washdown with a more even spray pattern. Halo eyewash, operated by an ergonomic, highly visible push handle, provides effective wash down coverage and spray pattern. Integral strainer reduces debris in the water and also prevents clogging.

 *This plumbing fixture is not intended to dispense water for human consumption through drinking or for preparation of food or beverages.*

#### Pipe and Fittings

Piping to 1-1/4" NPT water supply inlet on unit. Piping to 1-1/4" NPT drain outlet. 1-1/4" piping assembly manufactured of one of the following materials:

- Galvanized steel with BradTect® safety yellow coating

#### Ball Valve

1" shower ball valve and 1/2" stay-open eyewash valve manufactured of the following materials and supplied with type 304 stainless steel pull rod and handle:

- Chrome-plated brass

#### SpinTec™ Showerhead

Standard showerhead is 3.1" (78.7mm) diameter highly visible yellow impact-resistant plastic. SpinTec drench showerhead features integral 22 GPM (83.3 L) flow control (exceeds minimum water flow of 20 GPM (75.7L) at 30 PSI (2.0 bar)), conserving water and helping to accurately size your tepid water system.

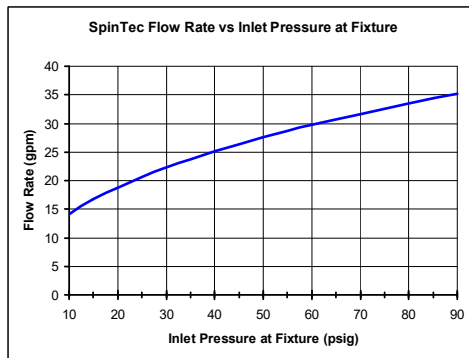

#### Eyewash

The Halo eyewash system offers a high performance rinsing platform that provides rapid relief to an individual's eyes that have been injured by chemicals or particulate. The eyewash includes an integral 5.1 GPM (19.2 L) flow control, providing water at a safe velocity while maintaining its effectiveness (exceeds minimum water flow of 0.4 GPM (1.5 L) at 30 PSI (2.0 bar)). The eyewash is protected by flip open dust covers that open when the product is activated by Type 304 stainless steel push handle. Safe, steady water flow under varying water supply conditions from 30–90 PSI (2.0–6.1 bar) is assured by integral flow control in the sprayhead assembly. Sprayheads are made from an impact resistant ABS plastic.

#### Bowl

Bowl is constructed of yellow impact-resistant plastic.

 *For information on all available S19314 models, please see tech data document Bradley\_SafetyCombi\_S19314Series.*

Model	Description
S19314EW	Halo Eyewash, plastic showerhead & bowl

### Tepid Water Options

[Navigator S19-2150 EFX20  
Emergency Thermostatic Mixing Valve](#)

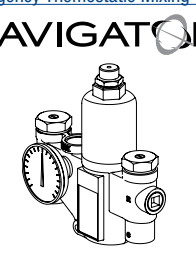

[Keltech SNA-Series  
Tankless Water Heater](#)

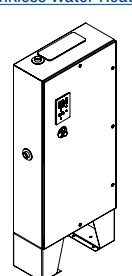

Satisfies ANSI/ISEA Z358.1 tepid water requirements.



A WATTS Brand

# S19314EW

## Combination Drench Shower and Halo™ Eyewash

### S19314 shown with Plastic Bowl and Showerhead

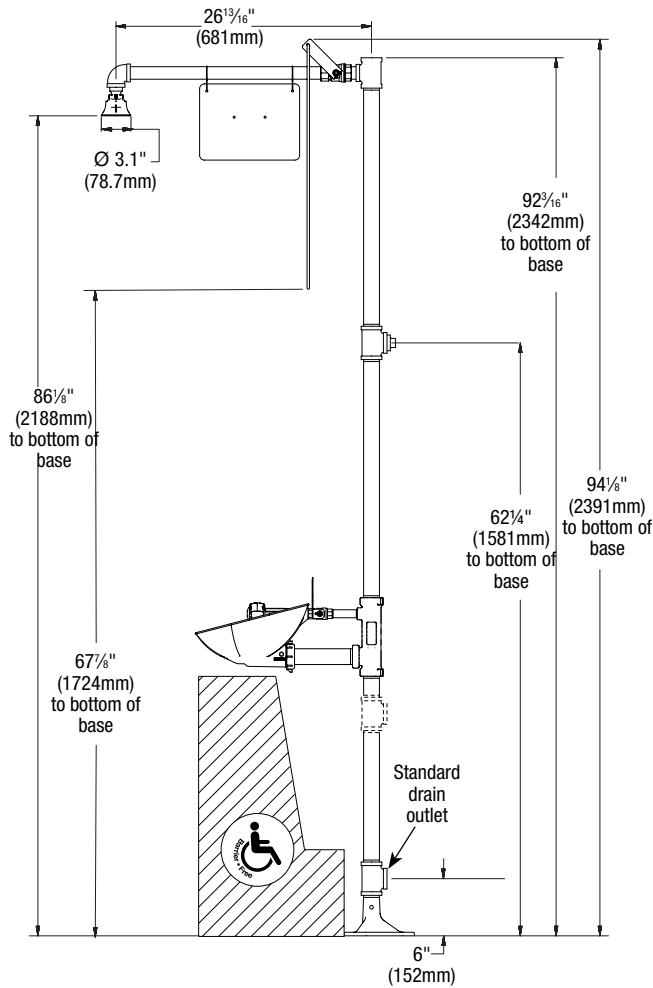

Eyewash Bowl

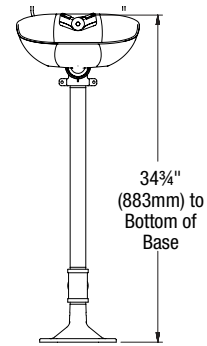
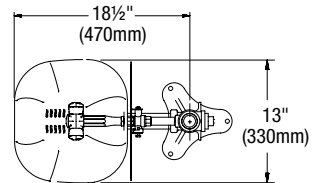

All dimensions assume standard thread engagement. Variations in manufacturing allow for  $\pm 1/8"$  (3mm) per threaded joint. To find the tolerance of a dimension, add the number of thread joints across the length of the dimension and multiply it by  $1/8"$  (3mm).